

NEW
KEYCHAINS

HDKDF12



HDKCF12-K
3M
CARBON
FIBER
VINYL
INLAY



HDKDB175
2-SIDED



NEW
LICENSE PLATE FRAMES

3M CARBON FIBER VINYL INLAY

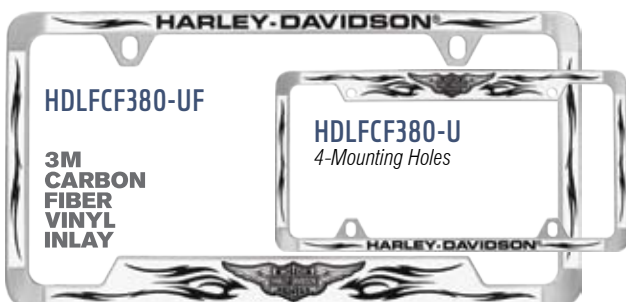

NEW
BLACK VALVE STEM CAPS - TPMS COMPLIANT



NEW
TRAILER HITCH COVERS

HDHC379



NEW
3D LICENSE PLATE

3M CARBON FIBER VINYL OVERLAY



TABLE OF CONTENTS:

NEW ITEMS2-3 ▪ SUMMER 2015 RELEASES4 ▪ AUTO BLING ITEMS5 ▪ LICENSE PLATE FRAMES5-11 ▪ VALVE STEM CAPS11
KEYCHAIN DISPLAY CASES & KITS12 ▪ INTERCHANGABLE KEYCHAINS13-14 ▪ BLING KEYCHAINS14 ▪ KEYCHAINS15-17
HITCH COVERS18-19 ▪ FRONT PLATES20-21 ▪ TOW BALL HITCH COVERS22-23



©2016 H-D or its Affiliates. HARLEY, HARLEY-DAVIDSON and the Bar & Shield Design are among the trademarks of H-D U.S.A. LLC, Baron & Baron Inc. is a licensee of Harley-Davidson Motor Company.

NEW

KEYCHAINS • NEW 2-SIDED MODEL • 3M CARBON FIBER VINYL INLAY • 3D



HDKDB175

Willie G Skull on front with the Bar & Shield on the back. Black epoxy imprints. Size: 4.25" x 1.5"



3M CARBON FIBER VINYL INLAY

HDKCF12-K

Plain Bar & Shield with Black simulated carbon fiber inlays. Size: 3.86" x 1.75"



HDKDF12

Round filigree fob with the Bar & Shield in the center. Black epoxy imprints. Size: 4.2" x 1.75"

NEW

BLACK VALVE STEM CAPS • TPMS COMPLIANT

All Black-coated Plastic Valve Stem Covers for your Tires. TPMS Compliant, including inner "O" ring seal ensuring a clean valve orifice to maintain consistent tire pressure. Package comes with 5 caps.

5

5 caps in each package!



HDVCK14-K



HDVCK240-K



HDVCK12-K

2-4 SCREW CAPS included in all License Plate, License Frame packaging

NEW

TRAILER HITCH COVERS



HDHC379 (2" post)

Willie G. Skull emblem with Black color filled imprints.

NEW

3D LICENSE PLATE

3M CARBON FIBER VINYL OVERLAY

HDLPDCF379

Willie G. Skull emblem on a black stainless steel plate with a 3M Black simulated carbon fiber vinyl overlay.



NEW

LICENSE PLATE FRAMES

3M CARBON FIBER VINYL INLAY

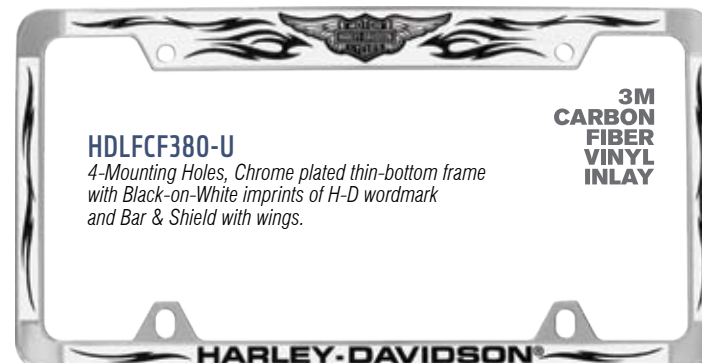

HDLFCF380-U

4-Mounting Holes, Chrome plated thin-bottom frame with Black-on-White imprints of H-D wordmark and Bar & Shield with wings.

3M CARBON FIBER VINYL INLAY

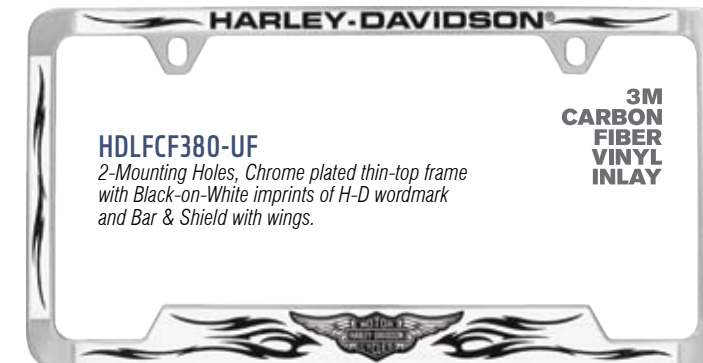

HDLFCF380-UF

2-Mounting Holes, Chrome plated thin-top frame with Black-on-White imprints of H-D wordmark and Bar & Shield with wings.

3M CARBON FIBER VINYL INLAY



HDLFCFT381

Black-coated thin-rim frame with White-on-Black Plain Bar & Shield and H-D wordmark imprints.

3M CARBON FIBER VINYL INLAY

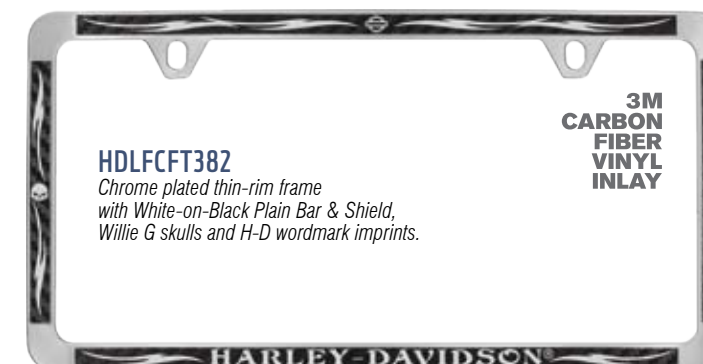

HDLFCFT382

Chrome plated thin-rim frame with White-on-Black Plain Bar & Shield, Willie G skulls and H-D wordmark imprints.

3M CARBON FIBER VINYL INLAY

2015 SUMMER

SUMMER 2015 RELEASE



HDKY368
Don't limit yourself with just one style keychain. Let your imagination go wild as you create a unique one-of-a-kind keychain with this interchangeable 4-piece keychain gift set. This design piece is embellished with Swarovski® crystals. Size: 1.5" x 5.1"

Mix & Match Gift Set



3M CARBON FIBER VINYL INLAY

HDKCF363-K
Bar & Shield, 3M Carbon fiber vinyl inlay. Size: 1.25" x 4.38"

HDKY364
This design piece is embellished with Swarovski® crystals. Bar & Shield, antique finish, heart keychain. Size: 1.75" x 4.1"



3M CARBON FIBER VINYL INLAY

HDKCF369
Front & Back with 3M Carbon fiber vinyl inlays. Size: 1.26" x 4.28"

HDKD362
Harley-Davidson® Genuine Motor Oil Black epoxy imprints. Size: 1.5" x 4.3"

No Limits to your possibilities...



HDHC362 (2" post)
Harley-Davidson® Genuine Motor Oil Black color filled imprints.

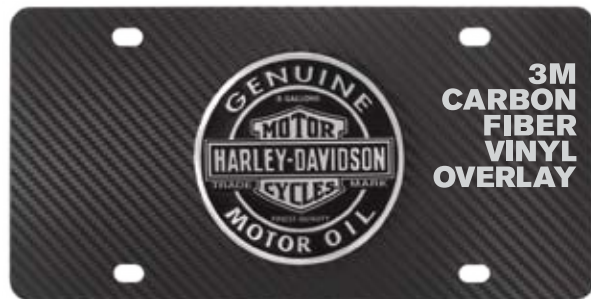

HDLPDCF362
HD motor oil emblem on a black stainless steel plate with a 3M carbon fiber vinyl overlay.



HDLFCF12
Chrome plated frame with Black 3M Carbon Fiber vinyl inlays. With the plain Bar & Shield and H-D wordmark.

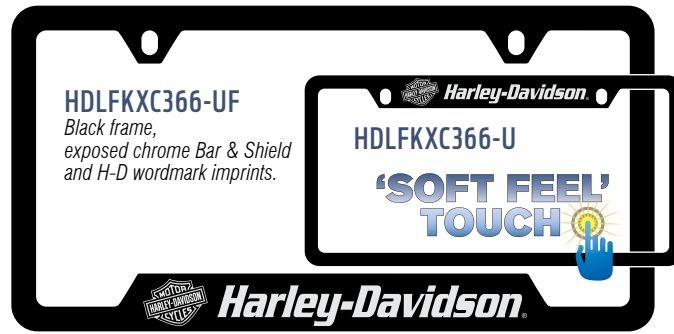

HDLFKXC366-UF
Black frame, exposed chrome Bar & Shield and H-D wordmark imprints.

HDLFKXC366-U

'SOFT FEEL TOUCH'

2-4 SCREW CAPS included in all License Plate, License Frame packaging

www.baronfi.com

WINTER 2016 ▶ DEALER

AUTO BLING® • CRYSTALS FROM SWAROVSKI®

4 SCREW CAPS included in all License Frame packaging

Frame Size: 12.25" W x 6.25" H



CRYSTALS FROM SWAROVSKI®

Swarovski® crystals is the premium brand for the finest crystal elements manufactured by Swarovski. Since 1895, these crystals have provided a fabulous palette of inspiration for designers in the worlds of fashion, jewelry, accessories, interior design and the lighting industry. The brand stands out by virtue of its creative and strong emotional appearance - it represents the rich cultural tradition of central Europe, and the ethics and technological innovation that are Swarovski hallmarks. Baron, in 2010, is proud to be an endorsed Swarovski Branded Partner Team.

Decorative Auto Bling® Chrome Plated Brass Medallion Frames, Trailer Hitch Covers, & 3D Front Plates

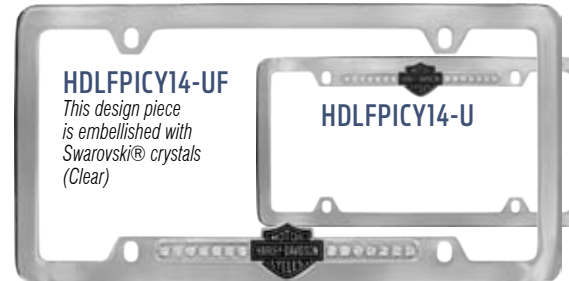

HDLFPICY14-UF
This design piece is embellished with Swarovski® crystals (Clear)

HDLFPICY14-U

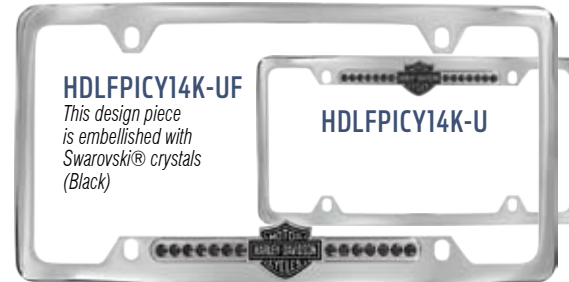

HDLFPICY14K-U
This design piece is embellished with Swarovski® crystals (Black)

HDLFPICY14K-U

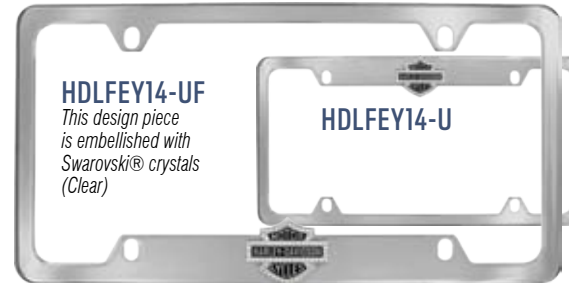

HDLFEY14-UF
This design piece is embellished with Swarovski® crystals (Clear)

HDLFEY14-U



HDHCEOPICY14
For 2" Receivers

Hitch cover & mirror polished stainless steel front vanity plate have chrome plated oval emblems. This design piece is embellished with Swarovski® crystals (Clear).



HDLDPICY14



HDHCKEOPICY14-K
For 2" Receivers

Hitch cover & Black coated stainless steel front vanity plate have black coated oval emblems. This design piece is embellished with Swarovski® crystals (Black).



HDLDPKICY14-K

Swarovski® is a registered trademark of Swarovski AG.

CONTOURED CUT OUT SERIES • FOR TOP & BOTTOM DECAL STATES

Contoured Cut Out Frames are Chrome Plated Die Cast Zinc Alloy. Frame Size: 12.25"W x 6.25"H



HDLFC61



HDLFC233



HDLFC292

3D



HDLFCB274-UF

3D

2-4 SCREW CAPS included in all License Plate, License Frame packaging

www.baronfi.com

WINTER 2016 ▶ DEALER

www.baronfi.com

WINTER 2016 ▶ DEALER

U SEMI-UNIVERSAL FIT FRAMES

4 SCREW CAPS included in all License Frame packaging

Frame Size: 12.25"W x 6.25"H

'U' SEMI-UNIVERSAL FRAME SERIES (CHROME PLATED)

The LF-U/UF Semi-Universal frame is designed to accommodate all 50 states' Top/Bottom Decal readability and nearly all states, fulfilling 49 states' additional requirement to not obstruct states' name readability, with the exception of Texas in 2003 that mandates total visibility requiring absolutely no partial plate text obstruction, differing from the other 49 states more liberal readable partial obstruction allowance interpretation. This based on Baron's DMV state plate research compiled data to our best knowledge, updated June 2006, but not warranted to be 100% accurate as DMV plates design and policies periodically change and States Legislation regulations may also change requiring calling DMV for information, monitoring DMV websites, and checking Highway Patrols' DMV plate readability regulations interpretations for evolving updated information. Baron will continually post any changes on our web site: www.baronfi.com. Also, LF-U overcomes license frame readability difficulties on all vehicles & trucks built with elevated bumpers obstructing all or portions of the frame's bottom rim, as above photos illustrate, affecting all GM, some Ford, & some Toyota trucks. Frame dimensions: 12.25" W x 6.25" H.

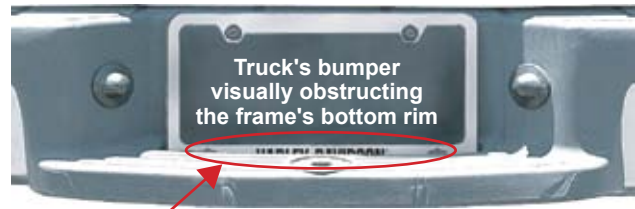

ill. 1 Above illustration of a standard frame. Bumper hides bottom frame rim.

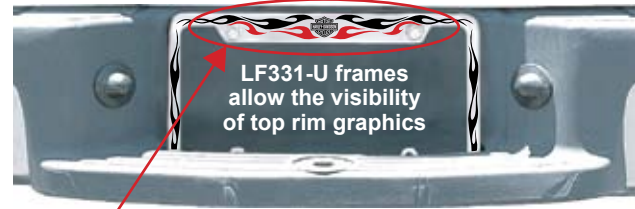

ill. 2 Above illustration with Baron LF331-U frame. Top frame rim graphics are clearly seen.

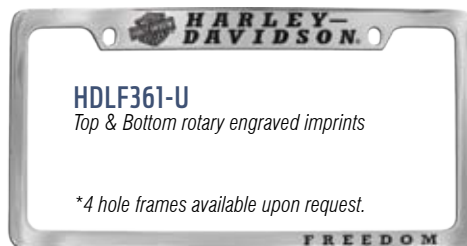
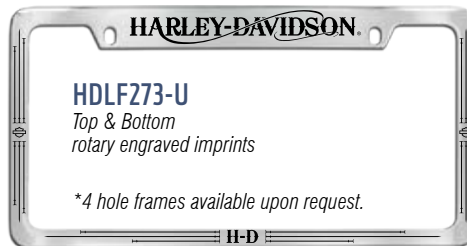
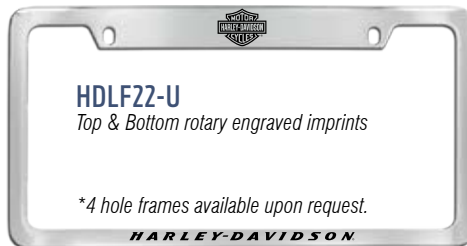
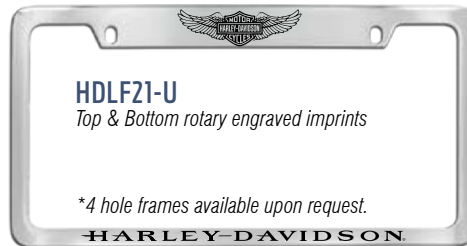
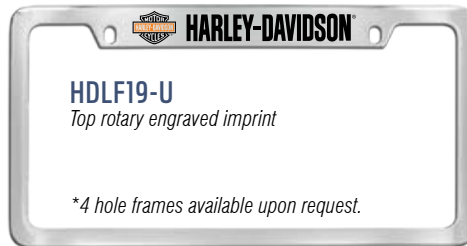

EZ with 3D EMBLEMS
HDLFE- Economical Zinc (EZ) 3D Die cast emblem badge, affixed with tape to the rim of these Die-cast Chrome Plated Zinc Frames. Frame Size: 12.25"W x 6.25"H.

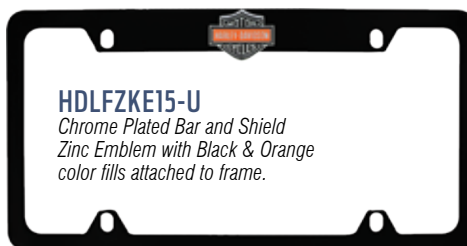
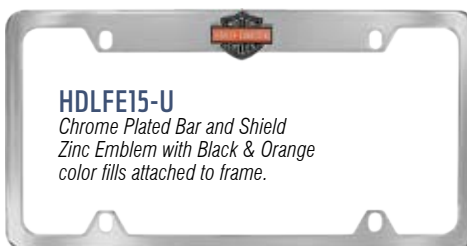

*Wide top, 2 hole frames with top imprints available upon request for the below states. See page 9 for reference. AL, CO, DE, IN, NH, NM, NC, ND, SC, WY.

UF SEMI-UNIVERSAL FIT FRAMES

4 SCREW CAPS included in all License Frame packaging

Frame Size: 12.25"W x 6.25"H

'UF' SEMI-UNIVERSAL FRAME SERIES (CHROME PLATED)

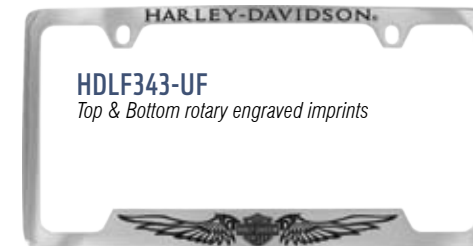
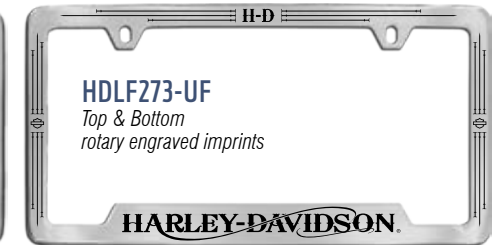
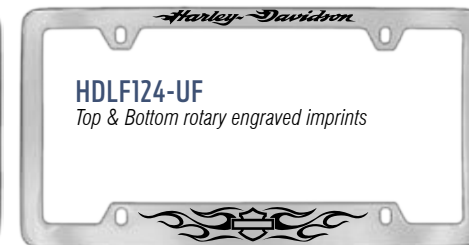
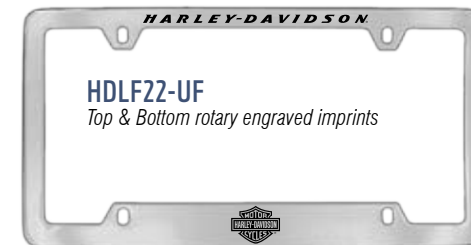
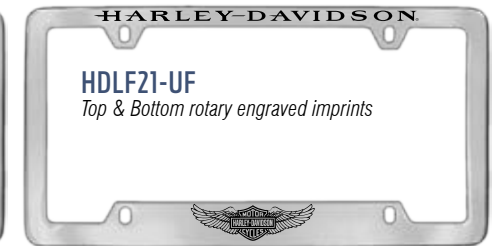
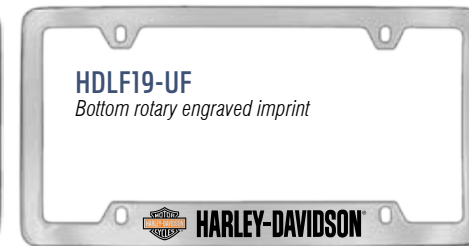
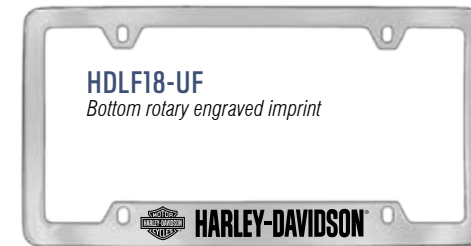

*Wide top, 2 hole frames with top imprints available upon request for the below states. See page 9 for reference. AL, CO, DE, IN, NH, NM, NC, ND, SC, WY.

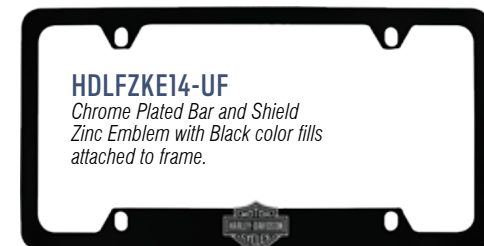
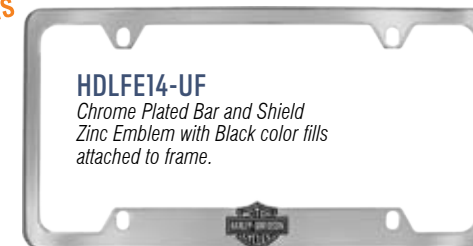

LICENSE FRAMES

4 SCREW CAPS included in packaging.

Frame Size: 12.25"W x 6.25"H

CONTEMPORARY BLACK FRAMES

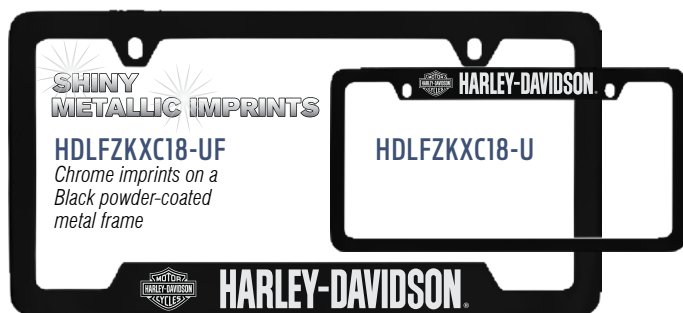
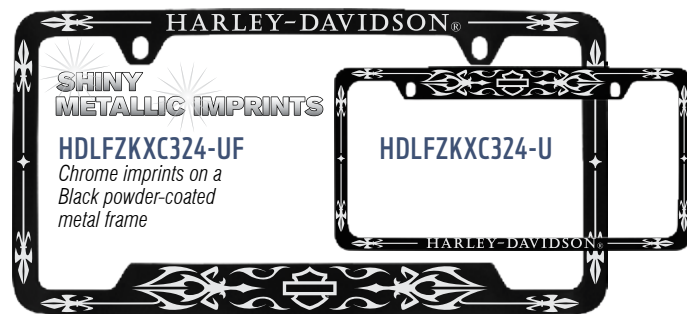
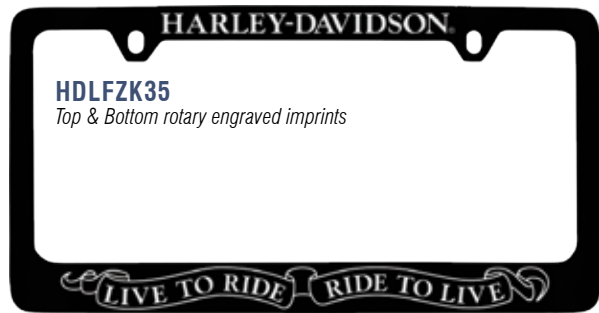
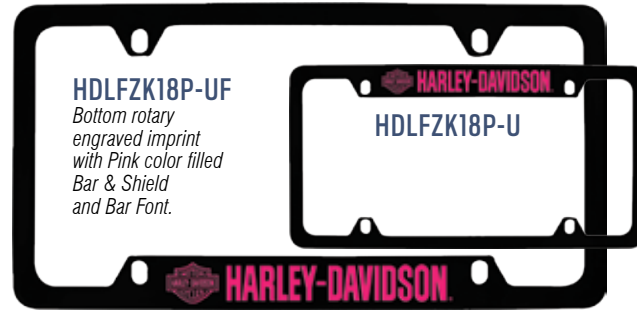
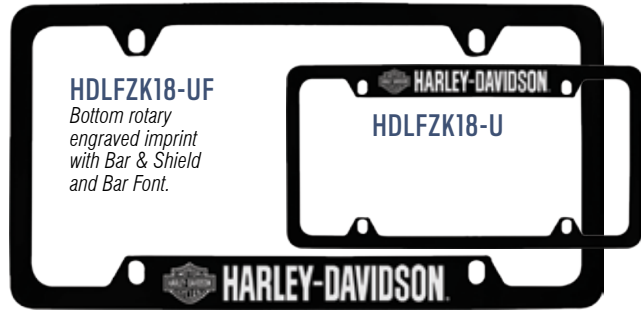
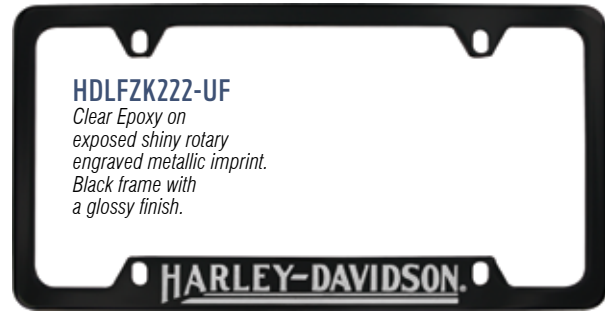
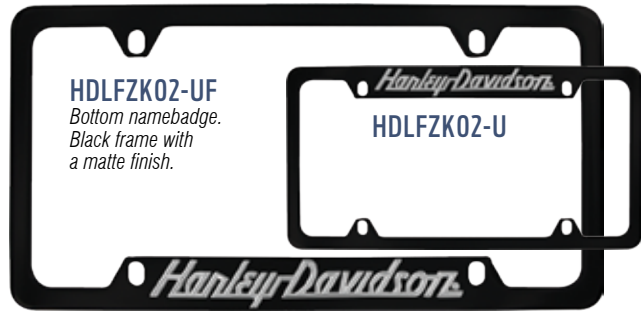

LICENSE FRAMES

2-4 SCREW CAPS included in packaging.

Frame Size: 12.25"W x 6.25"H

SIMULATED CARBON FIBER INLAY FRAMES

Frame Size: 12.25"W x 6.25"H

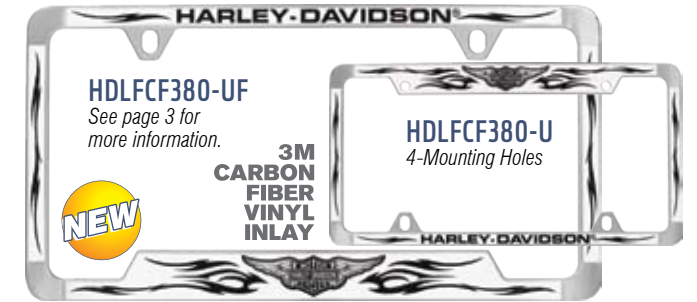
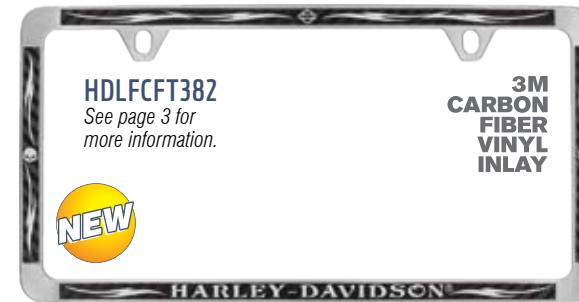

SLOGAN FRAME SERIES • FOR TOP & BOTTOM DECAL STATES

Chrome Plated Die Cast Zinc Alloy Frames with Raised Lettering. Frame Size: 12.25"W x 6.25"H

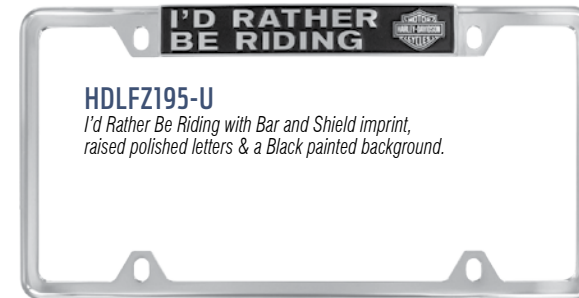

LICENSE FRAMES

2-4 SCREW CAPS included in packaging

All frames are Chrome Plated Solid Brass
Frame Size: 12.25"W x 6.25"H

T-SERIES THIN RIM 4-HOLE UNIVERSAL FRAMES

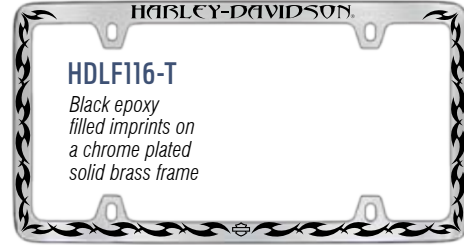
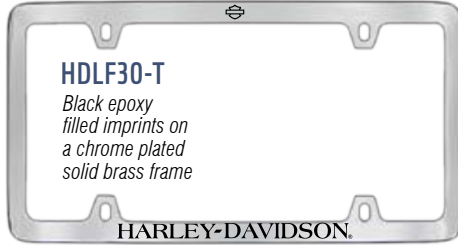

TECHNICAL INFORMATION.

For top/bottom mounting, accommodates all 50 States featuring engraved imprints on four thin 13mm rims that will not obstruct any States' visibility requirements, especially Texas since 2003 singularly mandating total visibility requiring absolutely no partial plate text obstruction, differing from the other 49 states' more liberal, readable partial obstruction allowance interpretation. This based on Baron's DMV state plate research compiled data to our best knowledge, updated June 2006, but not warranted to be 100% accurate as DMV plates design and policies periodically change and States Legislation regulations may also change requiring calling DMV for information, monitoring DMV websites, and checking Highway Patrols' DMV plate readability regulations interpretations for evolving updated information. Baron will continually post any changes on our web site: www.baronlfi.com.

ENGRAVED 322/329 SERIES

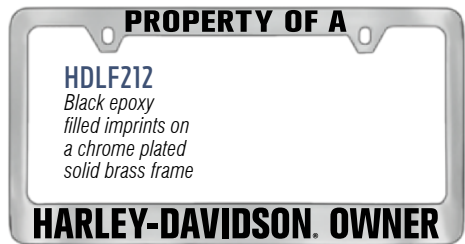
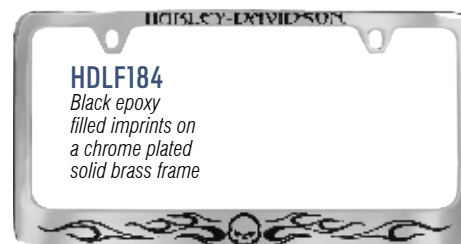
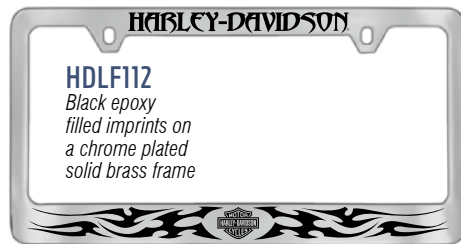
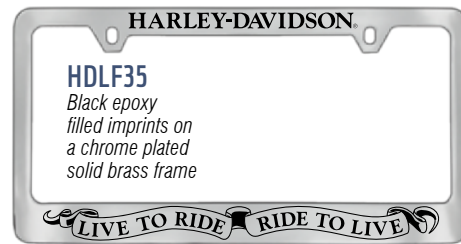
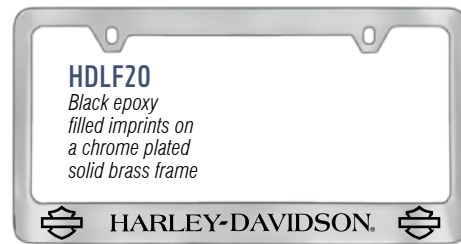
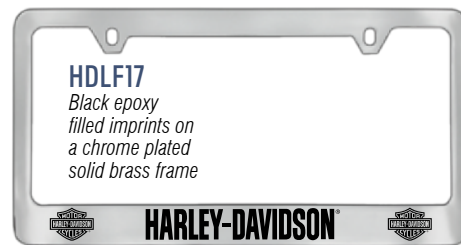
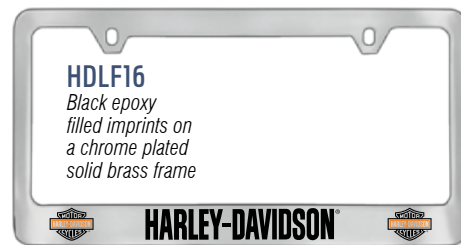

LF322 & LF329 accommodates specific State's vehicle plate visibility. This list is compiled by Baron to our best knowledge, updated June 2010, but not warranted 100% accurate as DMV plates periodically change designs and States Legislation regulations may also change requiring calling DMV for information, monitoring DMV websites, and checking Highway Patrols' DMV plate readability regulations interpretations for evolving updated information. Baron will continually post any changes on our web site: www.baronlfi.com.

This Top DMV Decal only states frame is compliant with these states:
AK, CA, CT, HI, IL, IN, KS, MD, MA, MI, MT, NE, NV, NJ, NY, OK, PA, TN, UT, VA, WA, WY

LICENSE FRAMES • VALVE CAPS

2 SCREW CAPS included in packaging.

Frame Size: 12.25"W x 6.25"H

'SOFT FEEL' TOUCH FRAMES

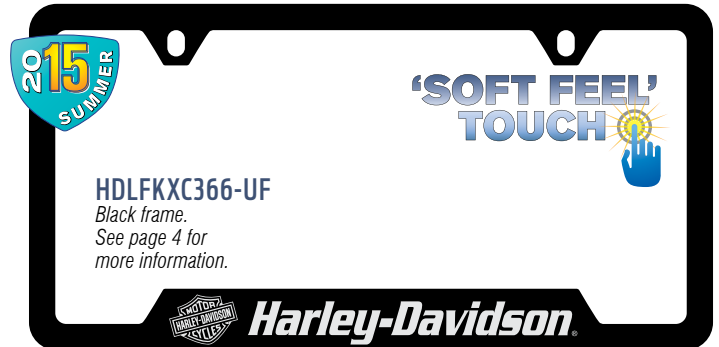
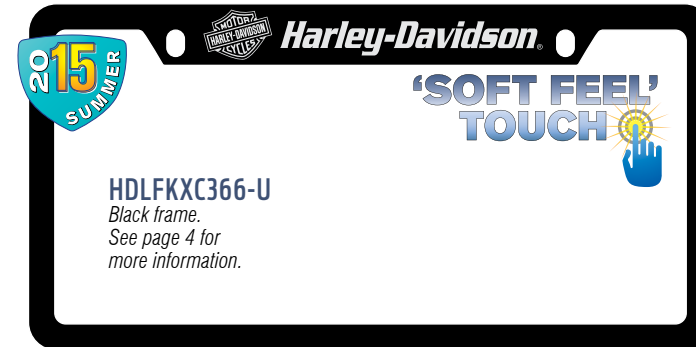
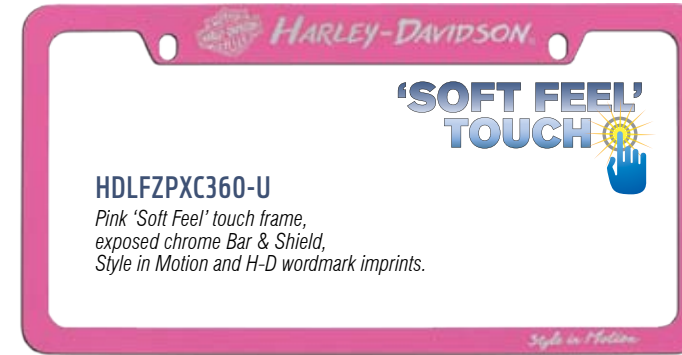

TPMS COMPLIANT VALVE STEM CAPS WITH H-D® IMPRINTS • (5 caps in package)

New Black-Finish and current Chrome Plated Plastic Valve Stem Covers for your Tires. TPMS Compliant, including inner "O" ring seal ensuring a clean valve orifice to maintain consistent tire pressure. UV-Resistant Film packaged in Hang-tab HD Box. TPMS sensor federally mandated installed all new vehicles sold after September 2007 electronically monitors air pressure. Package comes with 5 caps.



**CREATE
YOUR OWN
KIT**

KEYCHAIN KITS

24 various styles seen here inside our D25 spinning counter-top display



HDKJ144DKIT (side 1)
Sampling of 12 keychain styles shown here



HDKJ144DKIT (side 2)
Sampling of 12 keychain styles shown here

Shown above is a Suggested Kit (HDKJ144DKIT) and welcome Dealer's own preferred keychain selections. Please note, keychains in kits will change every 6 months.



D25
Elegant POP Spinner with Universal Key locks
1. Optimizes point of purchase presentation and location
2. Convenient and practical keychain merchandising
3. 2-sided, dual doors, easy access for greater visual impact at retail level
4. 360° revolving, scratch-resistant poly-carbonite plastic
5. Display spins on durable steel ball bearing lazy-susan base
6. Dimensions: 7" W x 15.5" H x 5.125" D.
Case includes 24 hooks holds 144 keychains

Below are the keychains used for this kit (HDKJ144DKIT)

- 1 HDKDF12
- 2 HDKDB175
- 3 HDKCF12-K
- 4 HDKCF369
- 5 HDKD362
- 6 HDKCF363-K
- 7 HDKY364
- 8 HDKD35
- 9 HDKDK86
- 10 HDKQCM357
- 11 HDKD334
- 12 HDKD354
- 13 HDKD15
- 14 HDK191
- 15 HDKD102
- 16 HDKB014
- 17 HDKD336
- 18 HDKD216
- 19 HDKD335
- 20 HDKD140
- 21 HDKPT15
- 22 HDKQCM25
- 23 HDKD239
- 24 HDKTPF14



HDKJ72DKIT
D25. w/72 Keychains
(3x 24 keychain models)



HDKJ144DKIT
D25. w/144 Keychains
(6x 24 keychain models)



Mix & Match

INTERCHANGEABLE MEDALLION KEYCHAINS EMBELLISHED WITH SWAROVSKI® CRYSTALS



HDKY12
Made with ENVIRONMENTALLY FRIENDLY MATERIALS. Stainless Steel Plain Bar and Shield keychain. This design piece is embellished with Swarovski® crystals. Emblem Size: 1-3/8" W x 1-3/8" H



HDKFSY191R
130, 2.4mm crystals protected with mini domes. Interchangeable Medallion keychain with removable clasp. Made with ENVIRONMENTALLY FRIENDLY MATERIALS. Stainless Steel Crystal Skull keychain. This design piece is embellished with Swarovski® crystals and a key ring imprinted with a laser engraved H-D® wordmark. Size: 3-7/8" L x 3/4" W.



Made with a Movable Jaw. Above close-up seen without keyring.

18" BELT LOOP FASHION KEYCHAINS



HDKMM12
For Him. An 18" long fashion keychain with dual clasps, key ring, and 3 interchangeable medallions. (M12, M14 & MS191)



VELOUR POUCH
This rich black velour pouch comes with many of our interchangeable medallion keychains. A beautiful bonus.



Comes with Velour pouch



HDKFMY12
For Her. An 18" long fashion keychain with dual clasps, key ring, and 3 interchangeable medallions. This design piece is embellished with Swarovski® crystals.



Comes with Velour pouch

Swarovski® is a registered trademark of Swarovski AG.

INTERCHANGEABLE MEDALLION KEYCHAINS

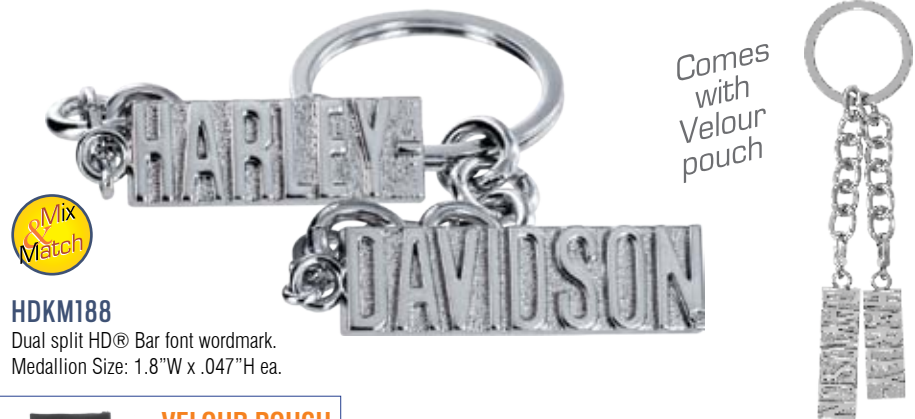

Comes with Velour pouch



HDKM188
Dual split HD® Bar font wordmark.
Medallion Size: 1.8"W x .047"H ea.

VELOUR POUCH
This rich black velour pouch comes with many of our interchangeable medallion keychains. A beautiful bonus.



Comes with Velour pouch

HDKMY12
Dual medallions. A Black filled Bar & Shield & a plain Bar & Shield. This design piece is embellished with Swarovski® crystals.
Medallion Size: 1"W x 1"H ea.



HDKY368
Don't limit yourself with just one style keychain. Let your imagination go wild as you create a unique one-of-a-kind keychain with this interchangeable 4-piece keychain gift set. This design piece is embellished with Swarovski® crystals.
Size: 1.5" x 5.1"



No Limits to your possibilities...



BLING KEYCHAINS EMBELLISHED WITH SWAROVSKI® CRYSTALS



Comes with Velour pouch

HDKY14
Bar and Shield keychain. This design piece is embellished with Swarovski® crystals.
Emblem Size: 1-13/16" W x 1-1/2" H



HDKY364
This design piece is embellished with Swarovski® crystals. Bar & Shield, antique finish, heart keychain.
Size: 1.75" x 4.1"

Swarovski® is a registered trademark of Swarovski AG.

KEYCHAINS



HDKCF363-K
Bar & Shield, 3M Carbon fiber vinyl inlay.
Size: 1.25" x 4.38"

HDKCF369
Front & Back with 3M Carbon fiber vinyl inlays.
Size: 1.26" x 4.28"

HDKCF12-K
Plain Bar & Shield with Black simulated carbon fiber inlays.
Size: 3.86" x 1.75"

HDKDF12
Round filigree fob with the Bar & Shield in the center. Black epoxy imprints.
Size: 4.2" x 1.75"

HDKDB175
Willie G Skull on front with the Bar & Shield on the back. Black epoxy imprints.
Size: 4.25" x 1.5"

SIMULATED CARBON FIBER INLAY KEYCHAINS



HDKD14
Bar and Shield. Emblem: 1.75"Wx1.4"H

HDKD15
Emblem Size: 1.75"W x 1.36"H

HDKD35
Live to Ride, Ride to Live keychain. Medallion size: 1.5" L x 1.25" H

HDKD86
Vintage Bar and Shield. Emblem: 2"W x 1.125"H

HDKDK86
Orange & White painted Dark Metal Vintage Bar & Shield. Fob Size: 2.0" wide

HDKD102
Emblem size: 1.55"Wx2.25"H



HDKD103
Emblem size: 1.55"W x 2.25"H

HDKD362
Genuine Motor Oil. Size: 1.5" x 4.3"

SKULL KEYCHAIN



HDK191
Moving Jaw Action! Metal Skull keychain with laser engraved Bar and Shield logo.
Size: 3-7/8" L x 3/4" W.

Actual size

Made with a Movable Jaw!

KEYCHAINS



HDKD140
Tribal design keychain.
Bar and Shield imprint.
Keychain size:
1.375"W x 3.25"H x .125"D



HDKB014
Dog Tag shaped
Bottle Cap Opener with
Bar and Shield imprint.
Size: 1-1/8"W x 4-5/8"H



HDKB0181
Dog Tag shaped
Bottle Cap Opener
with Willie G. imprint.
Size: 1-1/8"W x 4-5/8"H



HDKD153
Custom shaped
keychain.
Size: 1.4" W x 4" H



HDKD216
Custom shaped
keychain.
Size: 1.5"W x 4"H



HDKD282
Bar & Shield with
Rivets.
Size: 1.75"W x 4"H



HDKD239
Willie G imprint.
Size:
2"W x 4.75"H



HDKD317
Willie G, flame.
Size:
1"W x 4.375"H



HDKD333
Big Industrial
design with
rivets and the
Bar & Shield.
Size: 5" x 2"



HDKD334
Six sided shield
with the 3D
Willie G skull.
Size:
4.25" x 1.625"



HDKD335
3D Red heart.
Dual inter-locking
hearts with a new
script H-D® font.
Size: 3.5" x 1.5"



HDKD336
3D Bar & Shield
with Red &
Orange flames.
Size:
3.125" x 1.75"



HDKMLF192
Size:
1.5"W x 5-1/8"H



HDKD352
Bar & Shield,
3D Fleur-de-lis.
Size: 1.5" x 4.3"



HDKD353
Industrial look,
Bar & Shield.
Size: 1.6" x 4.15"



HDKD354
Bar & Shield,
dark diamond plate.
Size: 1.53" x 4.4"



HDKQCM357
Carabiner, diamond plate,
broken H-D wordmark, B&S.
Size: 1.85" x 3.2"

KEYCHAINS



HDKMS15
Size: 2.7"W x 3.25"H



HDKPFE14-K
Black Nickel finish
Size: 1.1"W x 2.8"H



HDKPF15
Size: 1.1"W x 2.8"H



HDKPFE15-K
Black Nickel finish
Size: 1.1"W x 2.8"H



HDKPT15
Size:
1.2"W x 3.9"H



HDKQCM25
Carabiner keychain.
Size: 1.7"W x 6.0"L
Carabiner clip not for load bearing use.



HDKWI08
Size: 1.3"W x 2.7"H



HDKWI15
Size: 1.3"W x 2.7"H



HDKWIE14
Size: 1.3"W x 2.7"H

MULTI-FUNCTION KEYCHAINS



HDKTPF14
7-Tool keychain:
Flashlight, pliers,
bottle opener, knife, file,
phillips screw driver,
flat head screw driver
Opened Size: 2.25"W x 5.5"H



(Above, front view)



Now available
with a light!
(Back view)

HDKTK14
Multi-tools
Bottle opener, knife,
phillips screw driver,
flat head screw driver.
Size: 1.25"W x 2.25"H

TRAILER HITCH COVERS

All hitch covers are chrome plated solid brass or Zinc and firmly bolted onto a stainless steel receiver post.
Additional accessories include rubber gaskets, theft-resistant stainless steel screws, washers, & nuts.

TRAILER HITCH COVERS



HDHC06
For 2" Receivers

Willie G Millennium Skull
Chrome plated finish



HDHC06A
For 2" Receivers

Willie G Millennium Skull
Antique Nickel finish



HDHC12
For 2" Receivers

Black color filled
engraving



HDHC13
For 2" Receivers

Raised Monotone
Bar and Shield



HDHC13-K
For 2" Receivers

Black Nickel plated finish
Raised Monotone Bar and Shield



HDHC14
For 2" Receivers

Black color filled
Bar and Shield



HDHC25
For 2" Receivers

Orange, Black & White
color filled Bar and Shield



HDHC58
For 2" Receivers

Black color
filled engraving



HDHC86
For 2" Receivers

3D die cast
with Black color fills



HDHC86-K
For 2" Receivers

Above, Orange & White painted
3D Dark Metal Vintage Bar & Shield.

TRAILER HITCH COVERS

All hitch covers are chrome plated solid brass or Zinc and firmly bolted onto a stainless steel receiver post.
Additional accessories include rubber gaskets, theft-resistant stainless steel screws, washers, & nuts.

TRAILER HITCH COVERS



HDHC153
For 2" Receivers

Red, White, Blue & Black
color filled engraving



HDHC216
For 2" Receivers

Black color filled
engraving



HDHC240
For 2" Receivers

Black color filled
engraving



HDHC290
For 2" Receivers

3D Bar & Shield
on a diamond plate background



HDHCX325
For 2" Receivers

Exposed chrome imprint
on Black coated emblem



HDHC336
For 2" Receivers

3D Bar and Shield
with Red & Orange flames



HDHC362
For 2" Receivers

See page 4 for
more information.



HDHC3795
For 2" Receivers

See page 3 for
more information.

HITCH COVER COMPONENTS Additional accessories include rubber gaskets, theft-resistant stainless steel screws, washers, & nuts.

Below, images of 2 common post receivers.
2" square & mini 1.25" square.



HC: 2" post, 3 foam gaskets
& Locking bolt set.
NOT FOR 1.25" POST OPENINGS

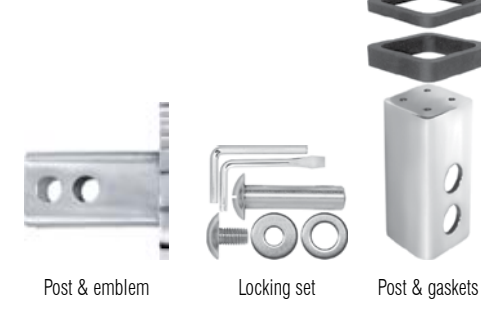

HCM: 1.25" post, 2 foam gaskets
& Locking bolt set.
NOT FOR 2" POST OPENINGS

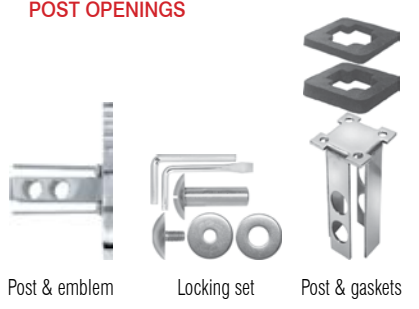

3D EMBLEM LICENSE PLATES

4 SCREW CAPS included in all License Plate packaging

3D FRONT PLATES • Stainless steel plates (Mirror polished or Black powder coated)

All emblems are Chrome Plated Solid Brass or Zinc. All plates are highly polished or Black powder coated stainless steel. Plate Size: 12.0"W x 6.0"H



HDLPD06



HDLPD06A



HDLPD12



HDLPD13



HDLPDK13 Black powder coated stainless steel plate



HDLPD14



HDLPDK14 Black powder coated stainless steel plate



HDLPD25



HDLPDK25 Black powder coated stainless steel plate



HDLPD58



HDLPD86

HD Front Plates allowed in the following states (State vehicle codes are subject to change): AL, AZ, AR, DE, DC, FL, GA, IN, KS, KY, LA, MI, MS, NM, NC, OK, PA, SC, TN, WV

3D EMBLEM LICENSE PLATES

4 SCREW CAPS included in all License Plate packaging

HD Front Plates allowed in the following states (State vehicle codes are subject to change): AL, AZ, AR, DE, DC, FL, GA, IN, KS, KY, LA, MI, MS, NM, NC, OK, PA, SC, TN, WV



HDLPDK86-K Black powder coated stainless steel plate



HDLPD153



HDLPD216



HDLPD240



HDLPDK240 Black powder coated stainless steel plate



HDLPD13-K



HDLPDK13-K Black powder coated stainless steel plate



HDLPD290



HDLPDKXC325



HDLPD336



HDLPDCF362 See page 4 for more information.



HDLPDCF379 See page 3 for more information.

All hitch covers are chrome plated solid brass or Zinc and firmly bolted onto a stainless steel receiver post. Baron's distinctive hitch cover box firmly secures high-end components for all hitch covers (HC, HCM, HCBE).

TOW BALL HITCH COVER (HCB)

New innovative design allows hitch covers to fit on your trailer tow balls!

- Theft resistant screws
- U-Clamp (for most hitch balls)

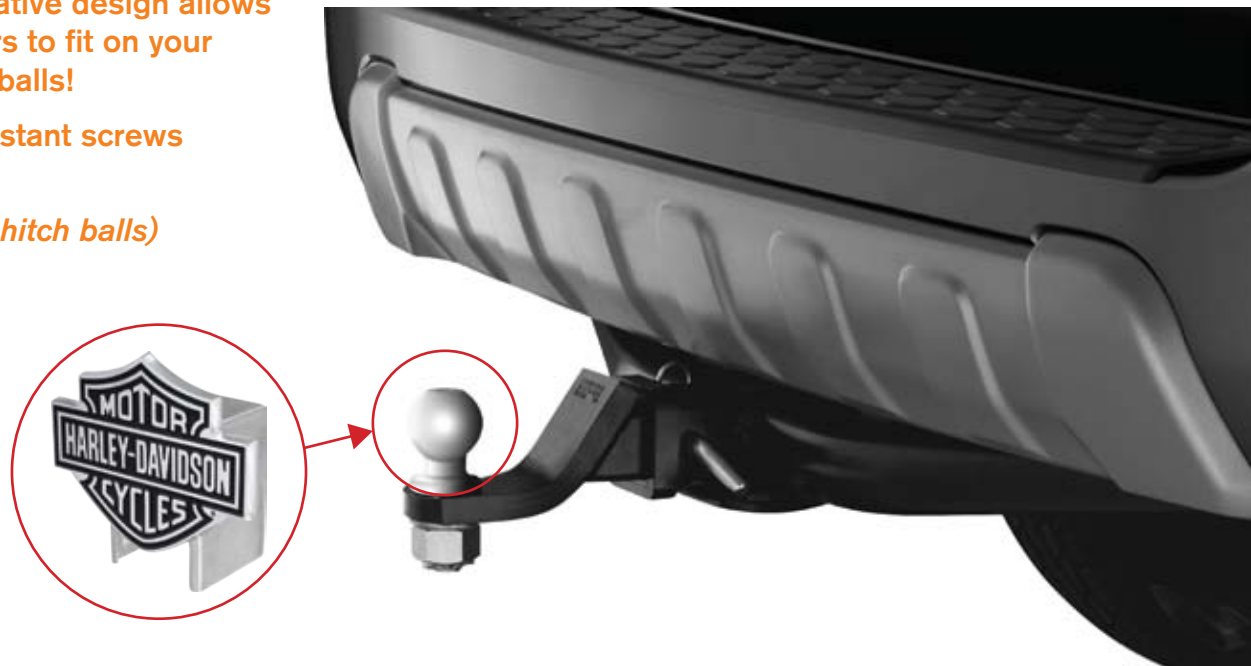

Below are the 5 Tow Ball Hitch Covers

HDHCB14	HDHCB25	HDHCB06	HDHCB216	HDHCB290

HITCH COVER COMPONENTS FOR *MOST COUNTRIES

- Innovative Tow Ball Post
- Theft resistant wrench
- Theft resistant screws
- Washers
- U-Clamp (patent pending)

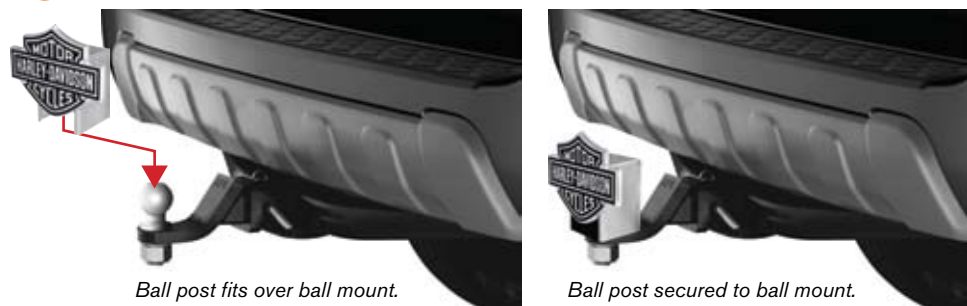

EUROPEAN TOW BALL HITCH COVER (HCBE)

New innovative design allows hitch covers to fit on European tow balls!

- Theft resistant screws
- U-Clamp E (European hitch balls)



Euro Ball is 50mm in diameter



There are two main categories of ISO tow ball: the flange fitting and the swan-neck which has an extended neck fitting into the tow-bracket. The flange type of towbar, common in the U.K., is non-removable.

HITCH COVER COMPONENTS FOR EUROPEAN APPLICATIONS

- Innovative Tow Ball Post
- Theft resistant wrench
- Theft resistant screws
- Washers
- U-Clamp E (patent pending)



TOW BALL HITCH COVER (HCB) also available for 5 Baron emblems ordered as HDHCB-PN



Below 5 HCBE hitch covers organized in ranked sales available primarily for EU

HDHCBE06
HDHCBE14
HDHCBE25
HDHCBE216
HDHCBE290

KEYCHAINS • FRAMES • HITCH COVERS & MORE



HDKJ144KIT (side 1)
Sampling of 12 keychain styles shown here

HDKJ144KIT (side 2)
Sampling of 12 keychain styles shown here

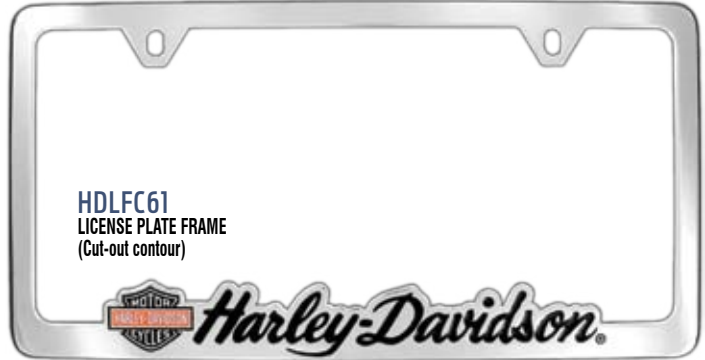

HDLFC61
LICENSE PLATE FRAME
(Cut-out contour)



HDLPD14
FRONT 3D VANITY PLATE



HDKD15
KEYCHAIN



HDHC14
TRAILER HITCH COVER



HDVC240
TPMS VALVE CAPS



©2016 H-D or its Affiliates. HARLEY, HARLEY-DAVIDSON and the Bar & Shield Design are among the trademarks of H-D U.S.A. LLC, Baron & Baron Inc. is a licensee of Harley-Davidson Motor Company.

BARON
Automotive Accessories Specialists

15462 Electronic Lane • Huntington Beach, CA 92649-1334
Toll Free: 800-232-2766 • Fax: 714-895-5105
OR CALL (Toll Free: 877-903-3555 • Tel: 714-903-7550 • Fax: 714-903-7530)
Web Site: www.baronfi.com • E-mail: Sales@baronfi.com

www.baronfi.com

WINTER 2016 ▶ DEALER