

# BARON

AUTOMOTIVE ACCESSORIES SPECIALISTS

**NEW**  
**KEYCHAINS**



HDKD362



HDKCF363-K

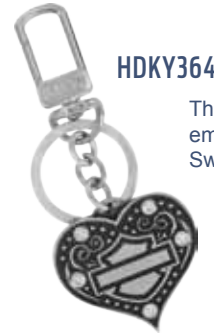

HDKY364

This design piece is embellished with Swarovski® crystals



HDKY368

Mix & Match Gift Set

4-piece keychain Gift Set. This design piece is embellished with Swarovski® crystals



HDKCF369

2-sided keychain with 3M Carbon fiber vinyl inlays

## KEYCHAIN KITS

CREATE YOUR OWN KIT

24 various styles seen here inside our D25 spinning counter-top display!

Shown here is a Suggested Kit (HDKJ144DKIT) and welcome Dealer's own preferred keychain selections. Please note, keychains in kits will change every 6 months.



HDKJ144DKIT (side 1)  
Sampling of 12 keychain styles shown here



HDKJ144DKIT (side 2)  
Sampling of 12 keychain styles shown here



©2015 H-D or its Affiliates. HARLEY, HARLEY-DAVIDSON and the Bar & Shield Design are among the trademarks of H-D U.S.A. LLC, Baron & Baron Inc. is a licensee of Harley-Davidson Motor Company.

# INTERCHANGEABLE FASHION KEYCHAINS



## INTERCHANGEABLE MEDALLION KEYCHAINS EMBELLISHED WITH SWAROVSKI® CRYSTALS



**HDKY12**

Made with ENVIRONMENTALLY FRIENDLY MATERIALS. Stainless Steel Plain Bar and Shield keychain. This design piece is embellished with Swarovski® crystals. Emblem Size: 1-3/8" W x 1-3/8" H



**HDKFSY191R**

130, 2.4mm crystals protected with mini domes. Interchangeable Medallion keychain with removable clasp. Made with ENVIRONMENTALLY FRIENDLY MATERIALS. Stainless Steel Crystal Skull keychain. This design piece is embellished with Swarovski® crystals and a key ring imprinted with a laser engraved H-D® wordmark. Size: 3-7/8" L x 3/4" W.



Made with a Movable Jaw. Above close-up seen without keyring.

## 18" BELT LOOP FASHION KEYCHAINS



**HDKMM12**

**For Him.** An 18" long fashion keychain with dual clasps, key ring, and 3 interchangeable medallions. (M12, M14 & MS191)



Comes with Velour pouch

**VELOUR POUCH**  
This rich black velour pouch comes with many of our interchangeable medallion keychains. A beautiful bonus.



**HDKFMY12**

**For Her.** An 18" long fashion keychain with dual clasps, key ring, and 3 interchangeable medallions. This design piece is embellished with Swarovski® crystals.



Comes with Velour pouch

Swarovski® is a registered trademark of Swarovski AG.





**INTERCHANGEABLE MEDALLION KEYCHAINS**



**HDKM188**

Dual split HD® Bar font wordmark.  
Medallion Size: 1.8"W x .047"H ea.



Comes with Velour pouch



**VELOUR POUCH**

This rich black velour pouch comes with many of our interchangeable medallion keychains. A beautiful bonus.



**HDKMY12**

Dual medallions. A Black filled Bar & Shield & a plain Bar & Shield. This design piece is embellished with Swarovski® crystals.  
Medallion Size: 1"W x 1"H ea.



Comes with Velour pouch

**BLING KEYCHAINS EMBELLISHED WITH SWAROVSKI® CRYSTALS**



**HDKY14**

Bar and Shield keychain. This design piece is embellished with Swarovski® crystals.  
Emblem Size: 1-13/16" W x 1-1/2" H

Comes with Velour pouch



Pink Crystals



Clear Crystals



**HDKCYH62**

Heart shaped keychain. This design piece is embellished with Swarovski® crystals and a decorative laser imprint.  
Size: 1.4"W x 2"H



**HDKCYH62BKN**

Heart shaped keychain. This design piece is embellished with Swarovski® crystals and a decorative laser imprint.  
Size: 1.4"W x 2"H

Swarovski® is a registered trademark of Swarovski AG.



**HDKD216**  
Custom shaped  
keychain.  
Size: 1.5"W x 4"H



**HDKD275**  
Willie G skull with  
dual crossed wrenches.  
Size: 1.75"W x 4"H



**HDKD276**  
Bar & Shield with  
dual crossed wrenches.  
Size: 1.75"W x 4"H



**HDKD282**  
Bar & Shield with  
Rivets.  
Size: 1.75"W x 4"H



**HDKD284**  
Bar & Shield with  
diamond plate.  
Size: 1.75"W x 4.375"H



**HDKD285**  
Willie G imprint with  
diamond plate.  
Size: 1.75"W x 4"H



**HDKD239**  
Willie G imprint.  
Size:  
2"W x 4.75"H



**HDKD317**  
Willie G, flame.  
Size:  
1"W x 4.375"H



**HDKD333**  
Big Industrial  
design with  
rivets and the  
Bar & Shield.  
Size: 5" x 2"



**HDKD334**  
Six sided shield  
with the 3D  
Willie G skull.  
Size:  
4.25" x 1.625"



**HDKD335**  
3D Red heart.  
Dual inter-locking  
hearts with a new  
script H-D® font.  
Size: 3.5" x 1.5"



**HDKD336**  
3D Bar & Shield  
with Red &  
Orange flames.  
Size:  
3.125" x 1.75"



**HDKMLF192**  
Size:  
1.5"W x 5-1/8"H



**HDKD352**  
Bar & Shield,  
3D Fleur-de-lis.  
Size: 1.5" x 4.3"



**HDKD353**  
Industrial look,  
Bar & Shield.  
Size: 1.6" x 4.15"



**HDKD354**  
Bar & Shield,  
dark diamond plate.  
Size: 1.53" x 4.4"



**HDKQCM357**  
Carabiner, diamond plate,  
broken H-D wordmark, B&S.  
Size: 1.85" x 3.2"



**HDKMS15**  
Size: 2.7"W x 3.25"H



**HDKPF14-K**  
Black Nickel finish  
Size: 1.1"W x 2.8"H



**HDKPF15**  
Size: 1.1"W x 2.8"H



**HDKPF15-K**  
Black Nickel finish  
Size: 1.1"W x 2.8"H



**HDKPT14**  
Size:  
1.125"W x 4"H



**HDKPT15**  
Size:  
1.2"W x 3.9"H



**HDKWI08**  
Size: 1.3"W x 2.7"H



**HDKWI15**  
Size: 1.3"W x 2.7"H



**HDKWI14**  
Size: 1.3"W x 2.7"H



**HDKQCM25**  
Carabiner keychain.  
Size: 1.7"W x 6.0"L

Carabiner clip not for load bearing use.

KEYCHAINS



**HDKB014**  
Dog Tag shaped  
Bottle Cap Opener with  
Bar and Shield imprint.  
Size: 1-1/8"W x 4-5/8"H



**HDKB0181**  
Dog Tag shaped  
Bottle Cap Opener  
with Willie G. imprint.  
Size: 1-1/8"W x 4-5/8"H



**HDKD14**  
Bar and Shield.  
Emblem: 1.75"Wx1.4"H



**HDKD15**  
Emblem Size:  
1.75"W x 1.36"H



**HDKD35**  
Live to Ride,  
Ride to Live keychain.  
Medallion size:  
1.5" L x 1.25" H



**HDKD86**  
Vintage Bar and Shield.  
Emblem: 2"W x 1.125"H



**HDKDK86**  
Orange & White painted  
Dark Metal Vintage Bar & Shield.  
Fob Size: 2.0" wide



**HDKD102**  
Emblem size:  
1.55"Wx2.25"H



**HDKD103**  
Emblem size:  
1.55"W x 2.25"H



**HDKD140**  
Tribal design keychain.  
Bar and Shield imprint.  
Keychain size:  
1.375"W x 3.25"H x .125"D



**HDKD153**  
Custom shaped  
keychain.  
Size: 1.4" W x 4" H

SKULL KEYCHAIN



Actual size

**HDK191**  
Moving Jaw Action!  
Metal Skull keychain with  
laser engraved Bar and Shield logo.  
Size: 3-7/8" L x 3/4" W.



Made with a Movable Jaw.  
Above close-up seen without keyring.



**MULTI-FUNCTION KEYCHAINS**

**HDKTPF14**

7-Tool keychain:  
Flashlight, pliers,  
bottle opener, knife, file,  
phillips screw driver,  
flat head screw driver  
Opened Size: 2.25"W x 5.5"H



(Above, front view)

**HDKTK14**

Multi-tools  
Bottle opener, knife,  
phillips screw driver,  
flat head screw driver.  
Size: 1.25"W x 2.25"H



Now available  
with a light!  
(Back view)



**HDKPL15**

Projector Flashlight with a  
Three Color Bar and Shield.  
Size: 0.5"W x 3.25"H



Simulated projection  
from Flashlight



**5 caps  
in each package!**

**TPMS COMPLIANT VALVE STEM CAPS WITH H-D® IMPRINTS**  
(5 caps in package)

Chrome Plated Plastic Valve Stem Covers for your Tires. TPMS Compliant, including inner "O" ring seal ensuring a clean valve orifice to maintain consistent tire pressure. UV-Resistant Film packaged in Hang-tab HD Box. TPMS sensor federally mandated installed all new vehicles sold after September 2007 electronically monitors air pressure. Package comes with 5 caps.



HDVC240



HDVC25



HDVC14



HDVC216W

**CREATE  
YOUR OWN  
KIT**

## KEYCHAIN KITS

24 various styles seen here inside our D25 spinning counter-top display



**HDKJ144DKIT (side 1)**  
Sampling of 12 keychain styles shown here



**HDKJ144DKIT (side 2)**  
Sampling of 12 keychain styles shown here

*Shown above is a Suggested Kit (HDKJ144DKIT) and welcome Dealer's own preferred keychain selections. Please note, keychains in kits will change every 6 months.*



### D25

Elegant POP Spinner with Universal Key Locks

1. Optimizes point of purchase presentation and location
2. Convenient and practical keychain merchandising
3. 2-sided, dual doors, easy access for greater visual impact at retail level
4. 360° revolving, scratch-resistant poly-carbonite plastic  
Display spins on durable steel ball bearing lazy-susan base
5. Dimensions: 7" W x 15.5" H x 5.125" D.  
Case includes 24 hooks holds 144 keychains

Below are the keychains used for this kit (HDKJ144DKIT)

- |              |             |
|--------------|-------------|
| 1 HDKCF369   | 13 HDKD15   |
| 2 HDKD362    | 14 HDK191   |
| 3 HDKCF363-K | 15 HDKD102  |
| 4 HDKY364    | 16 HDKB014  |
| 5 HDKD275    | 17 HDKD336  |
| 6 HDKD35     | 18 HDKD216  |
| 7 HDKDK86    | 19 HDKD335  |
| 8 HDKW115    | 20 HDKD317  |
| 9 HDKD334    | 21 HDKPT15  |
| 10 HDKD284   | 22 HDKQCM25 |
| 11 HDKD354   | 23 HDKD239  |
| 12 HDKD285   | 24 HDKTPF14 |



**HDKJ72DKIT**  
D25. w/72 Keychains  
(3x 24 keychain models)



**HDKJ144DKIT**  
D25. w/144 Keychains  
(6x 24 keychain models)



# EUROPEAN UNION LICENSE PLATE FRAMES

*Low freight costs within EU. No Duty.*

*Fits all EU countries except Australia & Switzerland. Manufactured/drop-shipped by experienced EU license frame factories delivering promptly.*

All Baron EU  
Frames fit  
Standard EU  
Plate dimension  
520x110mm



\*HDLFSKLEU184  
Stainless Powder-  
coat Black Laser  
Engrave exposed  
Stainless Harley-  
Davidson L/R  
Skull-Flame made  
in Germany

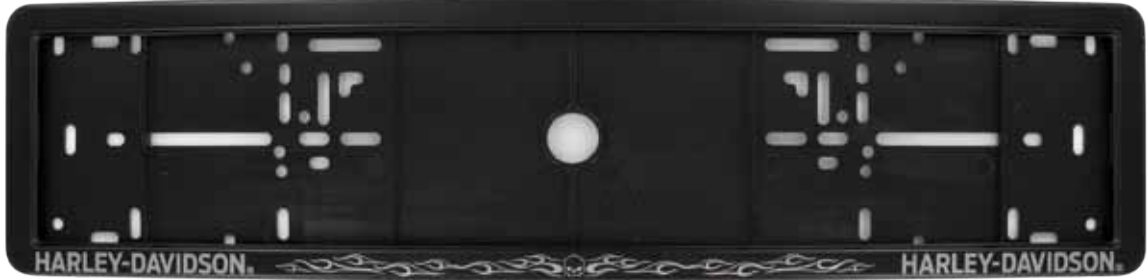

HDLFSCINEU445  
Stainless Chrome  
plated B&S-Black  
flanking Harley-  
Davidson Silverish  
contrast black  
background high  
quality resin UV-  
resistant Insert  
made in Germany

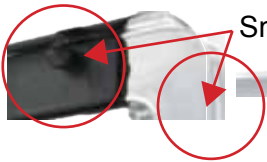

Smooth Polished Edges, Rear Snap Locking Prongs affixed mounting bracket

All EU frames contoured to match EU vehicle standard chassis curvature

\*HDLFPCEU184  
Plastic Digital Print  
Silver dome Black  
Harley-Davidson  
L/R Skull-Flame  
black, made in  
Austria



\*HDLFPCEU338  
Digital Print Silver  
dome Harley-  
Davidson Center  
B&S two colors  
Orange+Black L/R,  
made in Austria















EUROPEAN UNION



# TRAILER HITCH COVERS

All hitch covers are chrome plated solid brass or Zinc and firmly bolted onto a stainless steel receiver post.  
Additional accessories include rubber gaskets, theft-resistant stainless steel screws, washers, & nuts.

## TRAILER HITCH COVERS

 <p><b>HDHC06</b> For 2" Receivers</p> <p>Willie G Millennium Skull Chrome plated finish</p>	 <p><b>HDHC06A</b> For 2" Receivers</p> <p>Willie G Millennium Skull Antique Nickel finish</p>	 <p><b>HDHC12</b> For 2" Receivers</p> <p>Black color filled engraving</p>	 <p><b>HDHC13</b> For 2" Receivers</p> <p>Raised Monotone Bar and Shield</p>
 <p><b>HDHC13-K</b> For 2" Receivers</p> <p>Black Nickel plated finish Raised Monotone Bar and Shield</p>	 <p><b>HDHC14</b> For 2" Receivers</p> <p>Black color filled Bar and Shield</p>	 <p><b>HDHC25</b> For 2" Receivers</p> <p>Orange, Black &amp; White color filled Bar and Shield</p>	 <p><b>HDHC58</b> For 2" Receivers</p> <p>Black color filled engraving</p>
 <p><b>HDHC86</b> For 2" Receivers</p> <p>3D die cast with Black color fills</p>	 <p><b>HDHC86-K</b> For 2" Receivers</p> <p>Above, Orange &amp; White painted 3D Dark Metal Vintage Bar &amp; Shield.</p>	 <p><b>HDHC153</b> For 2" Receivers</p> <p>Red, White, Blue &amp; Black color filled engraving</p>	 <p><b>HDHC216</b> For 2" Receivers</p> <p>Black color filled engraving</p>

EUROPEAN UNION

# TRAILER HITCH COVERS

All hitch covers are chrome plated solid brass or Zinc and firmly bolted onto a stainless steel receiver post. Additional accessories include rubber gaskets, theft-resistant stainless steel screws, washers, & nuts.

## TRAILER HITCH COVERS



**HDHC240**  
For 2" Receivers

Black color filled engraving



**HDHC275**  
For 2" Receivers

Above, Chrome plated 3D Willie G skull over dual crossed wrenches.



**HDHC276**  
For 2" Receivers

Chrome plated 3D Bar & Shield over dual crossed wrenches.



**HDHC290**  
For 2" Receivers

3D Bar & Shield on a diamond plate background



**HDHCKXC325**  
For 2" Receivers

Exposed chrome imprint on Black coated emblem



**HDHC336**  
For 2" Receivers

3D Bar and Shield with Red & Orange flames



**HDHCEOPICY14**  
For 2" Receivers

Bar and Shield on a Chrome Emblem. This design piece is embellished with Swarovski® crystals (Clear).



**HDHCKEOPICY14-K**  
For 2" Receivers

Bar and Shield on a Black Emblem. This design piece is embellished with Swarovski® crystals (Black).

## HITCH COVER COMPONENTS

Additional accessories include rubber gaskets, theft-resistant stainless steel screws, washers, & nuts.

Below, images of 2 common post receivers. 2" square & mini 1.25" square.



**HC:** 2" post, 3 foam gaskets & Locking bolt set.  
**NOT FOR 1.25" POST OPENINGS**

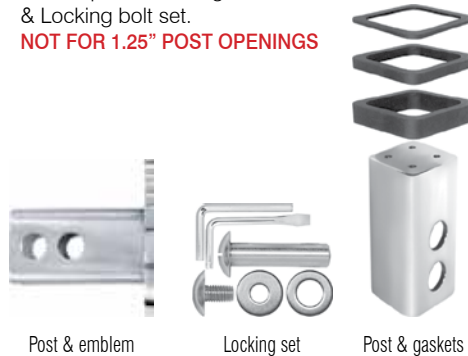

**HCM:** 1.25" post, 2 foam gaskets & Locking bolt set.  
**NOT FOR 2" POST OPENINGS**

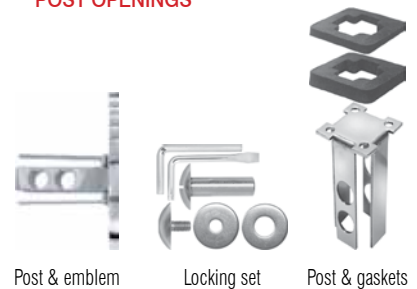



# NEW TRAILER HITCH BALL COVERS

## TOW BALL HITCH COVERS (HCB)

New innovative design allows hitch cover fit atop your trailer tow balls!

- Theft resistant screws
- U-Clamp fit all hitch balls diam 47.6mm, 50.8mm, 58.7mm

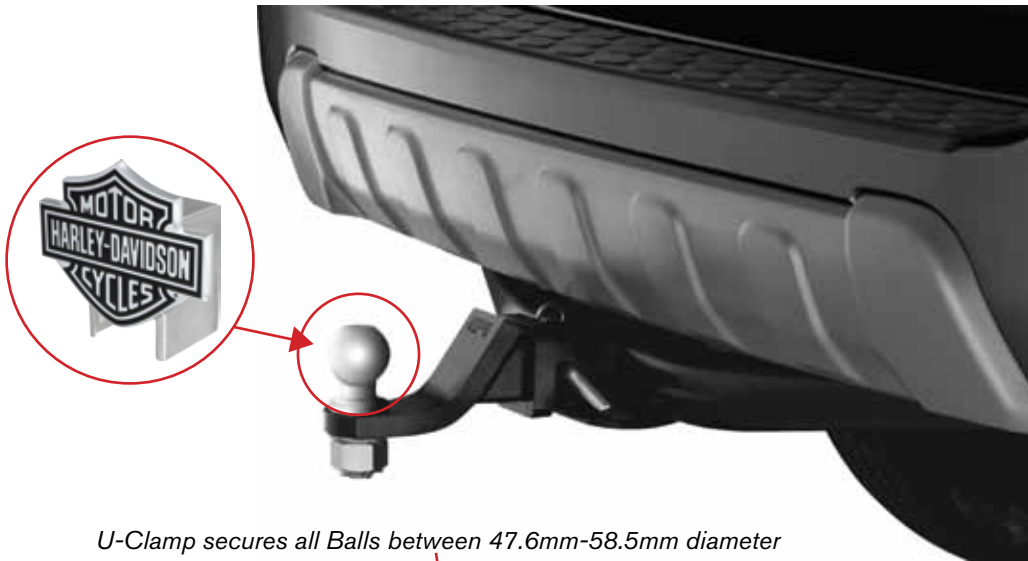

Below 5 HCB hitch covers organized in ranked sales available primarily for all countries other than EU N.A.

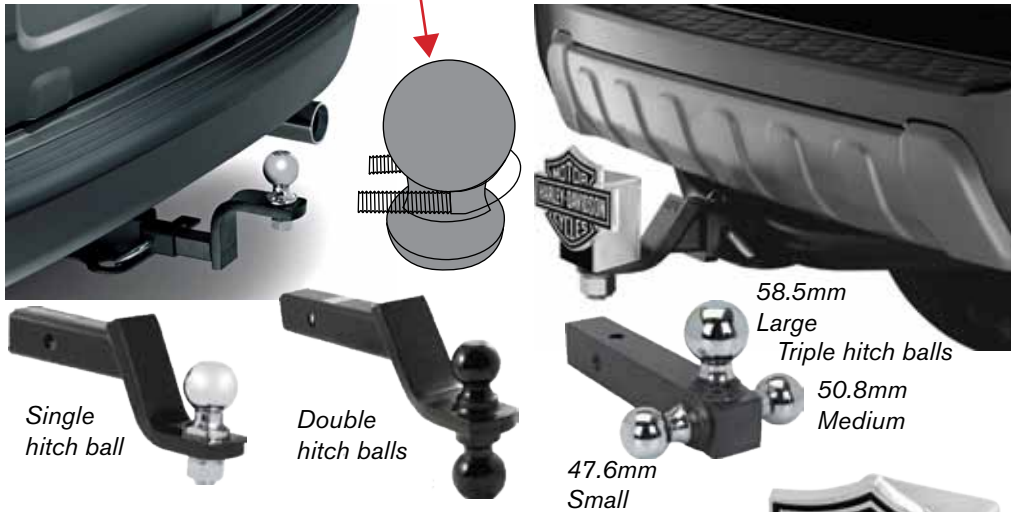

### HITCH COVER COMPONENTS FOR \*MOST COUNTRIES

- Innovative Tow Ball Post
- Theft resistant wrench
- Theft resistant screws
- Washers
- U-Clamp (patent pending)



\*European Union vehicles has limited imported Standard Flared Hitch Balls instead vehicles outfitted primarily Swan Neck Euro Balls

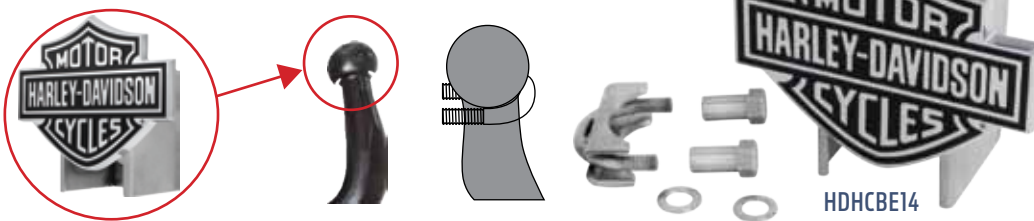

All Emblems available also as Standard HitchBall format, ordered as HDHCB-PN

HDHCB06
HDHCB14
HDHCB25
HDHCB216
HDHCB290

EUROPEAN UNION

# NEW TRAILER HITCH BALL COVERS

Secures all three standard Ball sizes:  
47.6-58.7mm and any dim. in between

## EUROPEAN TOW BALL HITCH COVER (HCBE)

New innovative design allows  
hitch covers to fit on  
European tow balls!

- Theft resistant screws
- U-Clamp E (*European hitch balls*)

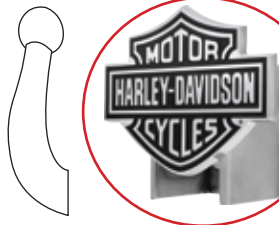

Below 5 HCBE hitch covers  
organized in ranked sales  
available primarily for EU

Euro Ball typically 50mm diam

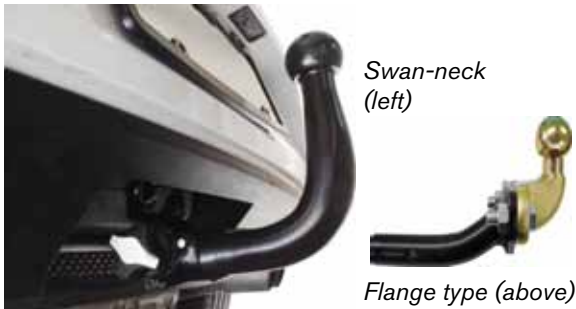

Swan-neck  
(left)

Flange type (above)



There are two main categories of ISO tow ball: the flange fitting and the swan-neck which has an extended neck fitting into the tow-bracket. The flange type of towbar, common in the U.K., is non-removable.



Swan-neck trailer hitch ball attached  
under typical European vehicle.

## HITCH COVER COMPONENTS FOR EUROPEAN APPLICATIONS

- Innovative Tow Ball Post
- Theft resistant wrench
- Theft resistant screws
- Washers
- U-Clamp E (*patent pending*)

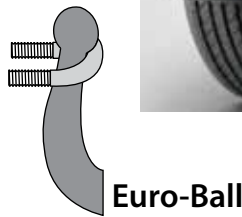

Euro-Ball

**TOW BALL HITCH COVER (HCB)** also available  
for 5 Baron emblems ordered as HDHCB-PN



HDHCBE14



HDHCBE06



HDHCBE14



HDHCBE25



HDHCBE216



HDHCBE290

EUROPEAN UNION

**BARON**  
Automotive Accessories Specialists

15462 Electronic Lane • Huntington Beach, CA 92649-1334  
Toll Free: 800-232-2766 • Fax: 714-895-5105  
OR CALL (Toll Free: 877-903-3555 • Tel: 714-903-7550 • Fax: 714-903-7530)  
Web Site: [www.baronfi.com](http://www.baronfi.com) • E-mail: [Sales@baronfi.com](mailto:Sales@baronfi.com)

[www.baronfi.com](http://www.baronfi.com)

SUMMER 2015 ▶ DEALER